

EDVOTEK® • The Biotechnology Education Company®

Edvo-Kit #225

Edvo-Kit #

225

DNA Fingerprinting Using Restriction Enzymes

Experiment Objective:

The objective of this simulated forensic analysis is to develop an understanding of the use of restriction enzymes as applied to RFLP-based DNA fingerprinting.

See page 3 for storage instructions.

Version 225.220526

PROTOCOL HAS BEEN UPDATED!
Please review before beginning experiment!

EDVOTEK®

1.800.EDVOTEK • www.edvotek.com • info@edvotek.com

Table of Contents

	Page
Experiment Components	3
Experiment Requirements	4
Introduction	5
Background Information	6
Experiment Procedures	
Experiment Overview	11
Module I: DNA Digestion with Restriction Enzymes	12
Module II: Gel Electrophoresis of Restriction Enzymes	14
Module III: (OPTIONAL) Staining Gels with FlashBlue™	18
Study Questions	19
Instructor's Guidelines	20
Notes to the Instructor	21
Pre-Lab Preparations	22
Expected Results	26
Study Questions	27
Appendix A: Troubleshooting Guide	28
Appendix B: Bulk Preparation of Electrophoresis Buffer and Agarose Gels	29

Safety Data Sheets can be found on our website: www.edvotek.com/safety-data-sheets

Technical Support
1.800.EDVOTEK
 Mon. - Fri. 8 AM to 5:30 PM EST

Please Have the Following Info:

- Product Number & Description
- Lot Number on Box
- Order/Purchase Order #

1.800.EDVOTEK • info@edvotek.com • www.edvotek.com

www.edvotek.com

- Online Catalog
- Order Products
- Experiment Protocols
- Tech Support
- Resources!

EDVOTEK and The Biotechnology Education Company are registered trademarks of EDVOTEK, Inc. FlashBlue, Dryzyme, and UltraSpec-Agarose are trademarks of EDVOTEK, Inc. SYBR is a registered trademark of Thermo Fisher Scientific.

All experiment components are intended for educational research only. They are not to be used for diagnostic or drug purposes, nor administered to or consumed by humans or animals.



1.800.EDVOTEK • Fax 202.370.1501 • info@edvotek.com • www.edvotek.com

Duplication of any part of this document is permitted for non-profit educational purposes only. Copyright © 2022 EDVOTEK, Inc., all rights reserved. 225.220526

Experiment Components

COMPONENTS

(Samples A and B are ready for electrophoresis)

	Storage	Check (✓)
A DNA Standard Marker	-20° C Freezer	<input type="checkbox"/>
B Crime scene DNA sample, pre-cut with Restriction Enzyme 1	-20° C Freezer	<input type="checkbox"/>
C Crime scene DNA sample, pre-cut with Restriction Enzyme 2	-20° C Freezer	<input type="checkbox"/>
D Suspect #1 DNA sample	-20° C Freezer	<input type="checkbox"/>
E Suspect #2 DNA sample	-20° C Freezer	<input type="checkbox"/>
F Enzyme Reaction Buffer	-20° C Freezer	<input type="checkbox"/>
G Dryzymes™ Restriction Enzyme 1 (<i>EcoRI</i>)	-20° C Freezer	<input type="checkbox"/>
H Dryzymes™ Restriction Enzyme 2 (<i>HindIII</i>)	-20° C Freezer	<input type="checkbox"/>
I Reconstitution buffer	-20° C Freezer	<input type="checkbox"/>

This experiment
is designed
for 8 gels.

NOTE:

This kit contains two staining options - SYBR® Safe and FlashBlue™. Only one of these dyes should be used at a time. Refer to the Instructor's Guide for more information.

REAGENTS & SUPPLIES

• UltraSpec-Agarose™	Room Temp.	<input type="checkbox"/>
• Electrophoresis Buffer (50x)	Room Temp.	<input type="checkbox"/>
• SYBR® Safe Stain	Room Temp.	<input type="checkbox"/>
• FlashBlue™ Gel Stain	Room Temp.	<input type="checkbox"/>
• 10X Gel Loading Solution	Room Temp.	<input type="checkbox"/>
• Practice Gel Loading Solution	Room Temp.	<input type="checkbox"/>
• 1 mL pipet	Room Temp.	<input type="checkbox"/>
• Microtipped Transfer Pipets	Room Temp.	<input type="checkbox"/>
• Microcentrifuge tubes	Room Temp.	<input type="checkbox"/>

Requirements *(not included with the experiment)*

- Horizontal gel electrophoresis apparatus
- D.C. power supply
- Automatic micropipettes with tips
- Balance
- Microwave, hot plate or burner
- Water bath (37°C)
- Pipet pump
- 250 mL flasks or beakers
- Small plastic trays or large weigh boats (for gel staining/destaining)
- UV Transilluminator or Blue Light visualization system (use if staining with SYBR® Safe)
- UV safety goggles (use if staining with SYBR® Safe)
- White light visualization system (use if staining with FlashBlue™)
- Distilled or deionized water
- Hot gloves
- Safety goggles and disposable laboratory gloves
- Laboratory journal



Background Information

RESTRICTION ENZYMES

One of the most significant discoveries of molecular biology is a class of enzymes known as restriction endonucleases. These endonucleases (also known as restriction enzymes) are produced by many species of bacteria to protect themselves from invading viral DNA. Restriction enzymes act like molecular scissors, cutting double-stranded DNA at specific sequences. The utility of restriction enzymes has made molecular cloning, DNA mapping, sequencing and various genome-wide studies possible, launching the era of biotechnology.

Restriction Enzyme	Organism	Species	Strain	Recognition Site
<i>Ava</i> I	<i>Anabaena</i>	<i>variabilis</i>	N/A	C [^] YCGUG
<i>Bgl</i> I	<i>Bactillus</i>	<i>globigii</i>	N/A	GCCNNNN [^] NGGC
<i>Eco</i> RI	<i>Escherichia</i>	<i>coli</i>	RY13	G [^] AATTC
<i>Hae</i> III	<i>Haemophilus</i>	<i>aegyptius</i>	N/A	GG [^] CC
<i>Hind</i> III	<i>Haemophilus</i>	<i>influenzae</i>	R ₄	A [^] AGCTT
<i>Sac</i> I	<i>Streptomyces</i>	<i>achromogenes</i>	N/A	GAGCT [^] C

Table 1: Common Restriction Enzymes

Since they were first discovered in the 1970s, over 3,000 restriction enzymes have been identified, each one given a unique acronym describing the organism from which it was first isolated. The first letter of the acronym is the first letter of the genus, the next two letters are the first two letters of the species name of the organism, and additional letters and numerals indicate specific strains and order of discovery. For example, *Eco*RI was the first restriction enzyme isolated from the RY13 strain of the bacterium *Escherichia coli*. (More examples are shown in Table 1.)

Many restriction enzymes require Mg²⁺ for activity and recognize palindromic stretches of DNA, generally 4-8 base pairs in length. The probability that a given enzyme will cut, or “digest”, a piece of DNA is directly proportional to the length of its recognition site. Statistically, an enzyme will average one cut for every 4ⁿ base pairs, where n is the length of the recognition site. For instance, an enzyme that recognizes a four base pairs long sequence (e.g., *Hae*III) will cut DNA once every 256 (or 4⁴) base pairs, while an enzyme that recognizes a six base pairs long site (e.g., *Eco*RI) will cut once every 4096 (or 4⁶) base pairs. Therefore, the longer a DNA molecule is, the greater the probability is that it contains one or more restriction sites. For example, if *Eco*RI is used to digest human chromosomal DNA containing 3 billion base pairs and a plasmid containing 5,000 base pairs, it will cut the chromosomal DNA over 700,000 times (3 billion base pairs, cut every 4096 base pairs), but may only cut the plasmid once (5,000 base pairs, cut every 4096 base pairs).

Digestion by a restriction enzyme generates DNA fragments with one of two types of DNA ends—"sticky" or "blunt". To illustrate this, first consider the recognition site and cleavage pattern of *EcoRI*.

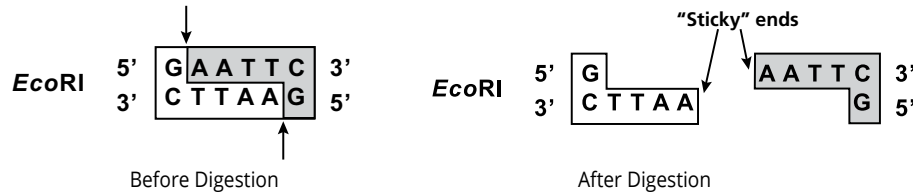

EcoRI cleaves between the G and neighboring A, as indicated by the arrows in the left side of the figure. It is important to note that the positions of the cleavage are staggered, so the resulting fragments project short overhangs of single-stranded DNA with complementary sequences. Such overhangs are referred to as "sticky" ends because the single-strands can interact with—or stick to—other overhangs with a complementary sequence. Digestion of the same piece of DNA using different enzymes can produce sticky ends of different lengths and strand orientation (5' vs. 3').

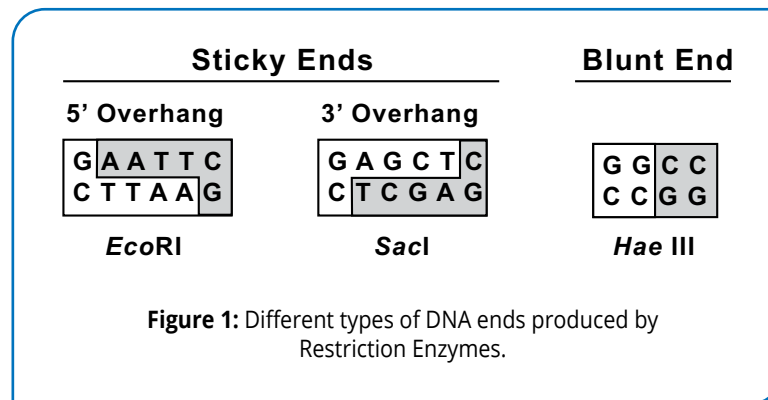

In contrast to *EcoRI*, *HaeIII* cuts both DNA strands at the same position, which generates fragments without an overhang. These so-called "blunt" ends can be joined with any other blunt end without regard for complementarity.

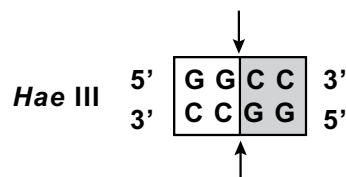

Some restriction enzymes, such as *AvaI*, recognize "degenerate" sites, which contain one or more variable positions.

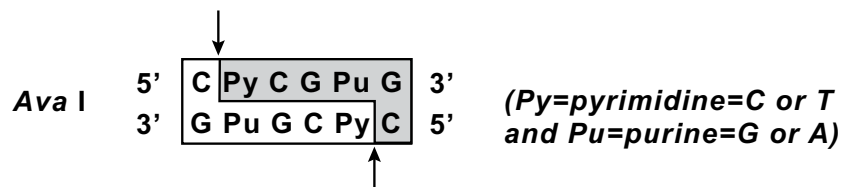

Consequently, there are four possible sites that *AvaI* will recognize and cut: CCCGGG, CCCGAG, CTCGGG and CTCGAG.

There are even enzymes like *Bgl*I that recognize “hyphenated” sites, which are palindromic sequences separated by a number of completely variable bases.

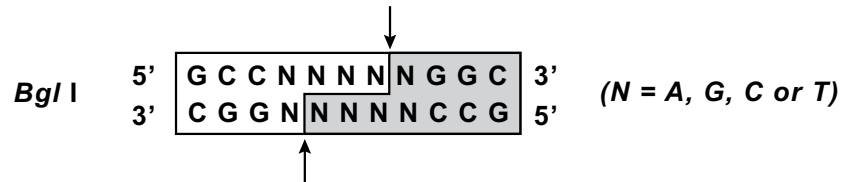

The six G-C base pairs that *Bgl*I specifically recognizes must be separated by five base pairs of DNA; otherwise the enzyme cannot properly interact with the DNA to cleave its backbone. Because these five base pairs are not required to make up a specific sequence, *Bgl*I can recognize and cleave up to 1024 possible sequences!

Depending on the distances between recognition sites, digestion of DNA by a restriction enzyme will produce DNA fragments of varying lengths. In order to analyze such a mixture of DNA fragments, scientists use a technique called agarose gel electrophoresis.

AGAROSE GEL ELECTROPHORESIS

Agarose gel electrophoresis separates DNA fragments according to size (see figure). First, DNA molecules are added into depressions (or “wells”) within a gel, and then an electrical current is passed through the gel. Because the sugar-phosphate backbone of DNA has a strong negative charge, the current drives the restriction fragments through the gel towards the positive electrode (Fig. 2)

At first glance, an agarose gel appears to be a solid at room temperature, but on the molecular level, the gel contains small channels through which the DNA can pass. Small DNA fragments move through these holes easily, but large DNA fragments have a more difficult time squeezing through the tunnels. Because molecules with dissimilar sizes travel at different speeds, they become separated and form discrete “bands” within the gel. After the current is stopped, the bands can be visualized using a stain that sticks to DNA.

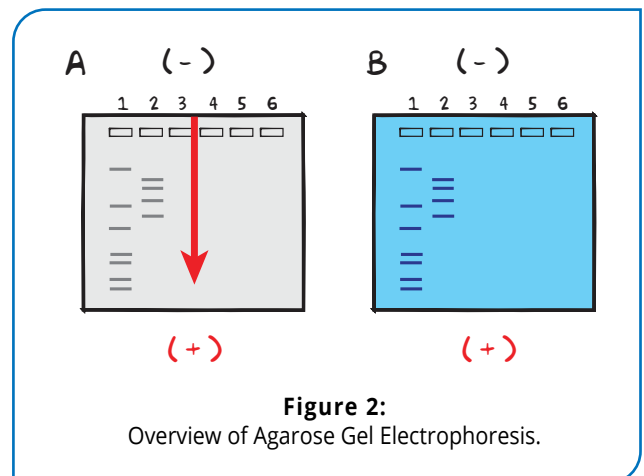

While electrophoresis is a powerful separation technique, it is not without its technical limitations. Most significantly, if two different fragments share a similar size, they will migrate together through the gel and may appear as a single band. In addition, if digestion results in a broad distribution of DNA sizes, the fragments may stain as a smear. Lastly, DNA with a streamlined secondary structure (such as supercoiled DNA) can pass through the gel more quickly than similarly-sized linear DNA, which prevents an accurate comparison of size.

SOUTHERN BLOT ANALYSIS

RFLP analysis of genomic DNA is facilitated by Southern blot analysis. After electrophoresis, DNA fragments in the gel are denatured by soaking in an alkali solution. This causes double-stranded fragments to be converted into single-stranded form (no longer base-paired in a double helix). A replica of the electrophoretic pattern of DNA fragments in the gel is made by transferring (blotting) them to a sheet of nitrocellulose or nylon membrane (Figure 3). This is done by placing the membrane on the gel after electrophoresis and transferring DNA fragments to the membrane by capillary action or electrotransfer. DNA, which is not visible, becomes permanently adsorbed to the membrane, that can then be manipulated easier than gels.

Analysis of the blotted DNA is done by hybridization with a labeled oligonucleotide DNA probe. The probe is a DNA fragment that contains base sequences that are complementary to the variable arrays of tandemly repeated sequences found in the human chromosomes. Probes can be labeled with reporter molecules that are used for detection. A solution containing the single-stranded probe is incubated with the membrane containing the blotted, single-stranded (denatured) DNA fragments. Under the proper conditions, the probe will only base pair (hybridize) to those fragments containing the complementary sequences. The membrane is then washed to remove excess probe. Only DNA fragments that are hybridized to the probe will reveal their positions on the membrane. If the probes are isotopically labeled, the hybridized fragments will appear as discrete bands (fingerprint) on the film and are in the same relative positions as they were in the agarose gel after electrophoresis. Only specific DNA fragments of the hundreds of thousands of fragments present, will hybridize with the probe because of the selective nature of the hybridization process.

In forensic analysis, DNA samples can be extracted and purified from specimens of skin, blood stains, semen, or hair roots collected at the crime scene. RFLP analyses performed on these samples is then compared to those performed on samples obtained from the suspect. If RFLP patterns match, it is beyond reasonable doubt that the suspect (or biological material from the suspect, such as blood) was at the crime scene. In forensic DNA fingerprinting, different sets of probes hybridized to different types of repetitious sequences are used in DNA profile analysis in order to satisfy certain statistical criteria for positive identification.

DNA FINGERPRINTING USING POLYMERASE CHAIN REACTION (PCR)

RFLP-based DNA fingerprinting analysis has been overtaken by the Polymerase Chain Reaction (PCR) because of two important advantages. The first is the sensitivity of PCR, which allows for DNA fingerprinting identification using much smaller amounts of DNA since PCR amplifies DNA. A second advantage is the speed of PCR analysis, which allows critical questions

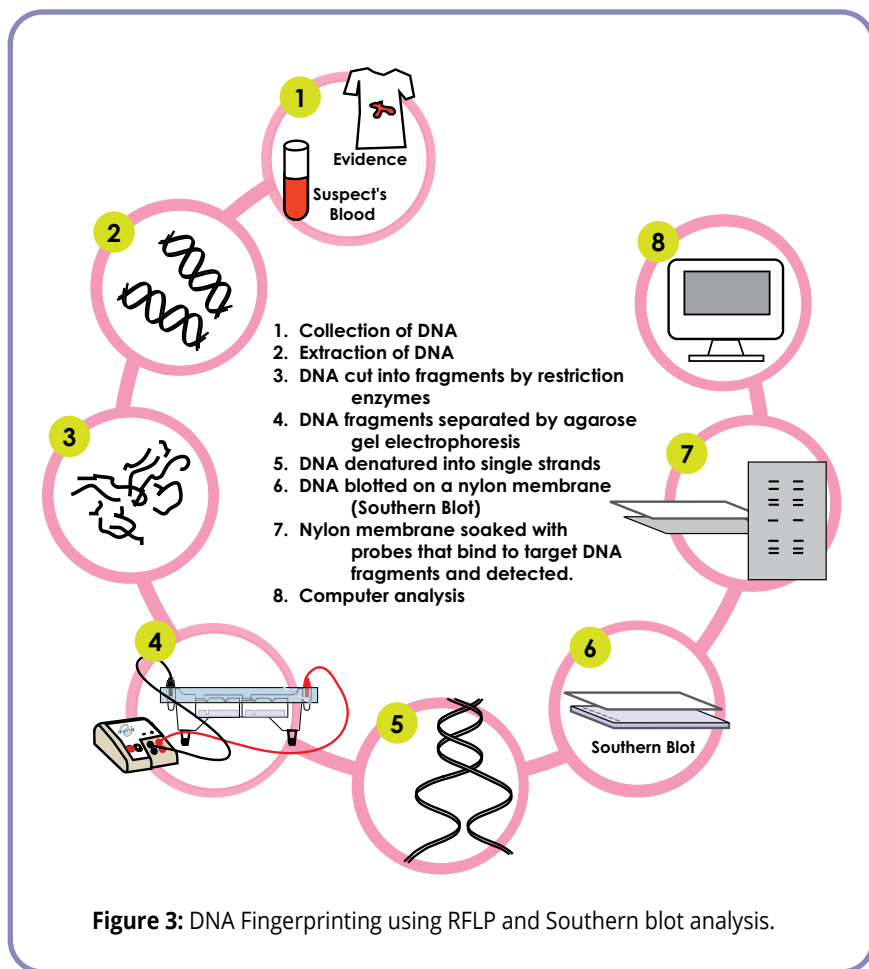

Figure 3: DNA Fingerprinting using RFLP and Southern blot analysis.

to be answered more quickly as compared to Southern Blot analysis.

PCR amplification requires the use of a thermostable DNA polymerase, such as *Taq* polymerase. Purified from a bacterium known as *Thermus Aquaticus* that inhabits hot springs, *Taq* polymerase is commonly used in PCR because it remains stable at near-boiling temperatures. Also included in the PCR reaction are the four deoxynucleotides (dATP, dCTP, dGTP, and dTTP) and two synthetic oligonucleotides, typically 15-30 base pairs in length, known as “primers”. These components, together with the DNA to be amplified, are incubated in an appropriate buffer that contains Mg^{2+} . The primers are designed to correspond to the start and end of the DNA to be amplified, known as the “target”.

The PCR reaction mixture (which contains the DNA polymerase, buffer, deoxynucleotides, primers, and template) is subjected to sequential heating/cooling cycles at three different temperatures (Figure 5).

- In the first step, the template is heated to near boiling ($92^{\circ} - 96^{\circ}C$) to denature or “melt” the DNA. This step, known as “denaturation” disrupts the hydrogen bonds between the two complimentary DNA strands and causes their separation.
- In the second PCR step, the mixture is cooled to a temperature that is typically in the range of $45^{\circ} - 65^{\circ}$. In this step, known as “annealing”, the primers, present in great excess to the template, bind to the separated DNA strands.
- In the third PCR step, known as “extension”, the temperature is raised to an intermediate value, usually $72^{\circ}C$. At this temperature the *Taq* polymerase is maximally active and adds nucleotides to the primers to complete the synthesis of the new complimentary strands.

DNA fingerprinting analysis has become increasingly significant in court cases involving murder, rape, physical battery, and other types of crimes. Jurors are often asked to determine the validity of DNA evidence, resulting in both acquittals and convictions of suspected criminals. To ensure greater accuracy, scientists have incorporated standardization procedures in DNA analysis. Standard DNA Fragments are used to determine the exact size of individual DNA fragments in a DNA fingerprint. It is generally accepted that DNA fingerprints are identical only in the case of identical twins.

In this experiment, emphasis is placed on concepts related to RFLP analysis. The experiment activities will focus on the identification of DNA by analyzing restriction fragmentation patterns separated by agarose gel electrophoresis.

THIS EXPERIMENT DOES NOT CONTAIN HUMAN DNA.

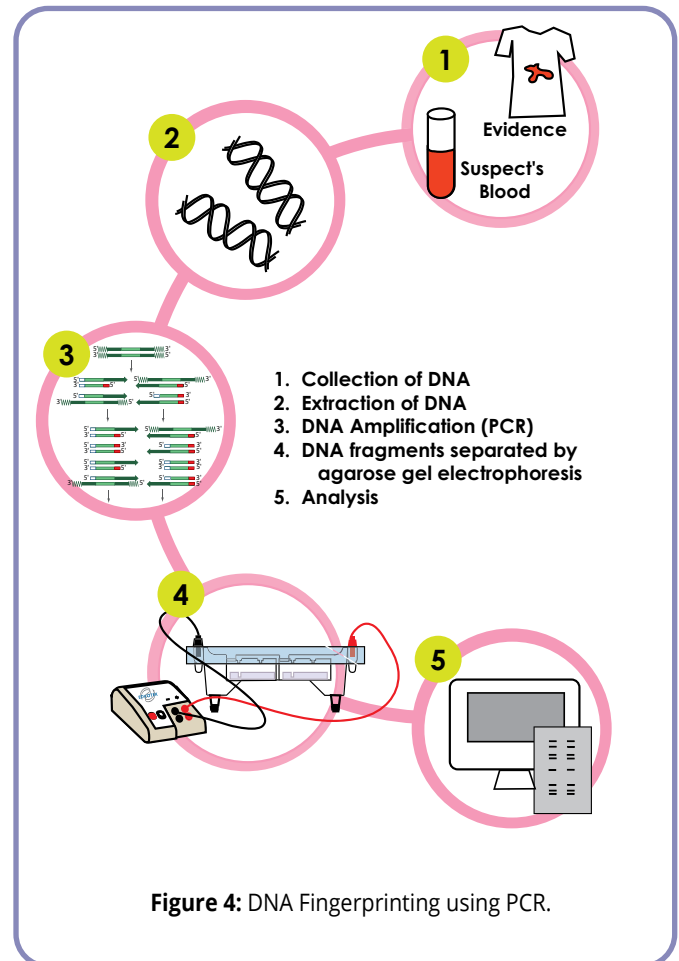

Figure 4: DNA Fingerprinting using PCR.

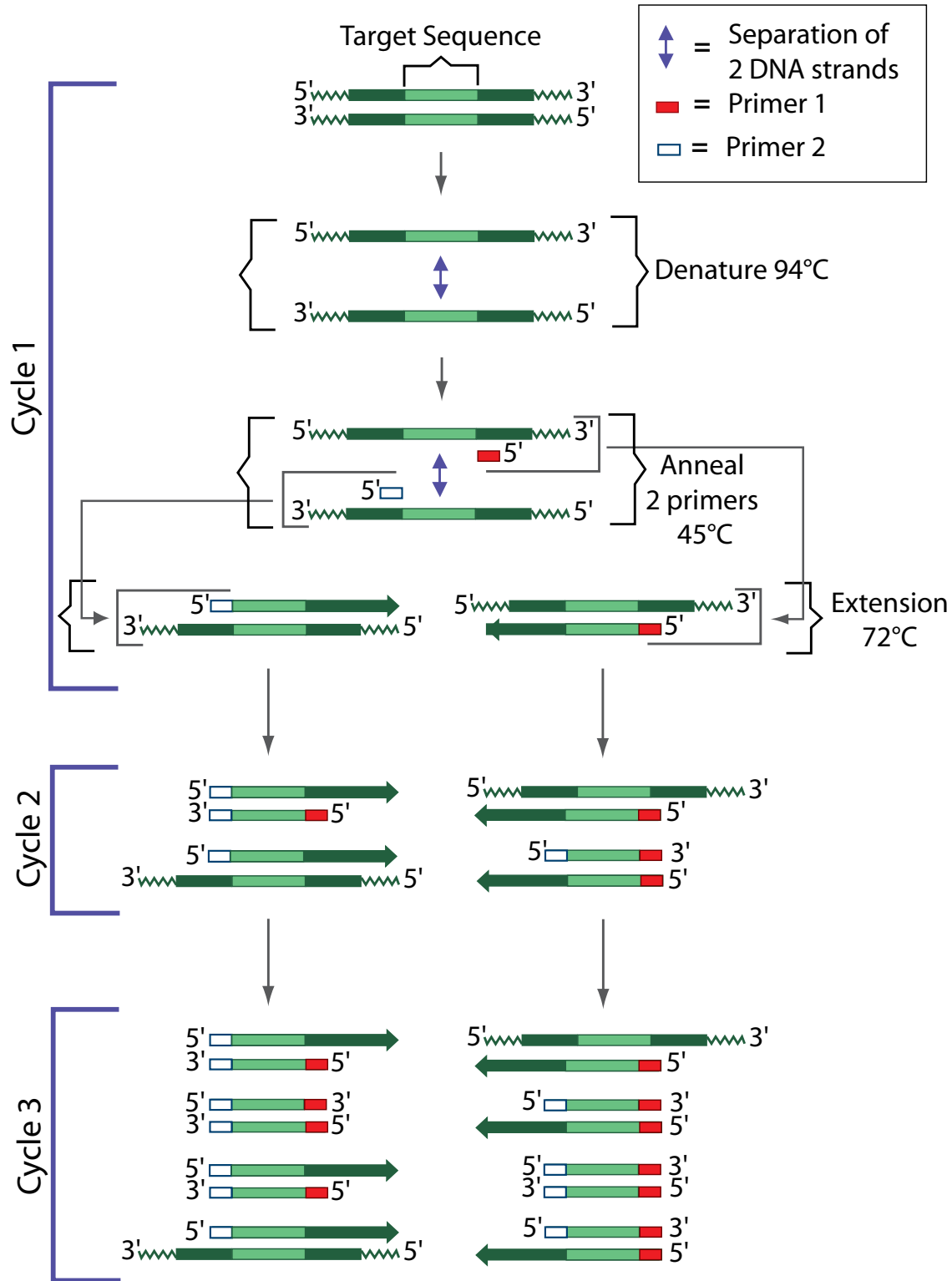

Figure 5: The Polymerase Chain Reaction

Experiment Overview

EXPERIMENT OBJECTIVE:

The objective of this simulated forensic analysis is to develop an understanding of the use of restriction enzymes as applied to RFLP-based DNA fingerprinting.

LABORATORY SAFETY

1. Gloves and goggles should be worn routinely as good laboratory practice.
2. Exercise extreme caution when working with equipment that is used in conjunction with the heating and/or melting of reagents.
3. DO NOT MOUTH PIPET REAGENTS - USE PIPET PUMPS.
4. Exercise caution when using any electrical equipment in the laboratory.
5. Always wash hands thoroughly with soap and water after handling reagents or biological materials in the laboratory.



LABORATORY NOTEBOOKS:

Scientists document everything that happens during an experiment, including experimental conditions, thoughts and observations while conducting the experiment, and, of course, any data collected. Today, you'll be documenting your experiment in a laboratory notebook or on a separate worksheet.

Before starting the Experiment:

- Carefully read the introduction and the protocol. Use this information to form a hypothesis for this experiment.
- Predict the results of your experiment.

During the Experiment:

- Record your observations.

After the Experiment:

- Interpret the results - does your data support or contradict your hypothesis?
- If you repeated this experiment, what would you change? Revise your hypothesis to reflect this change.

Module I: Overview

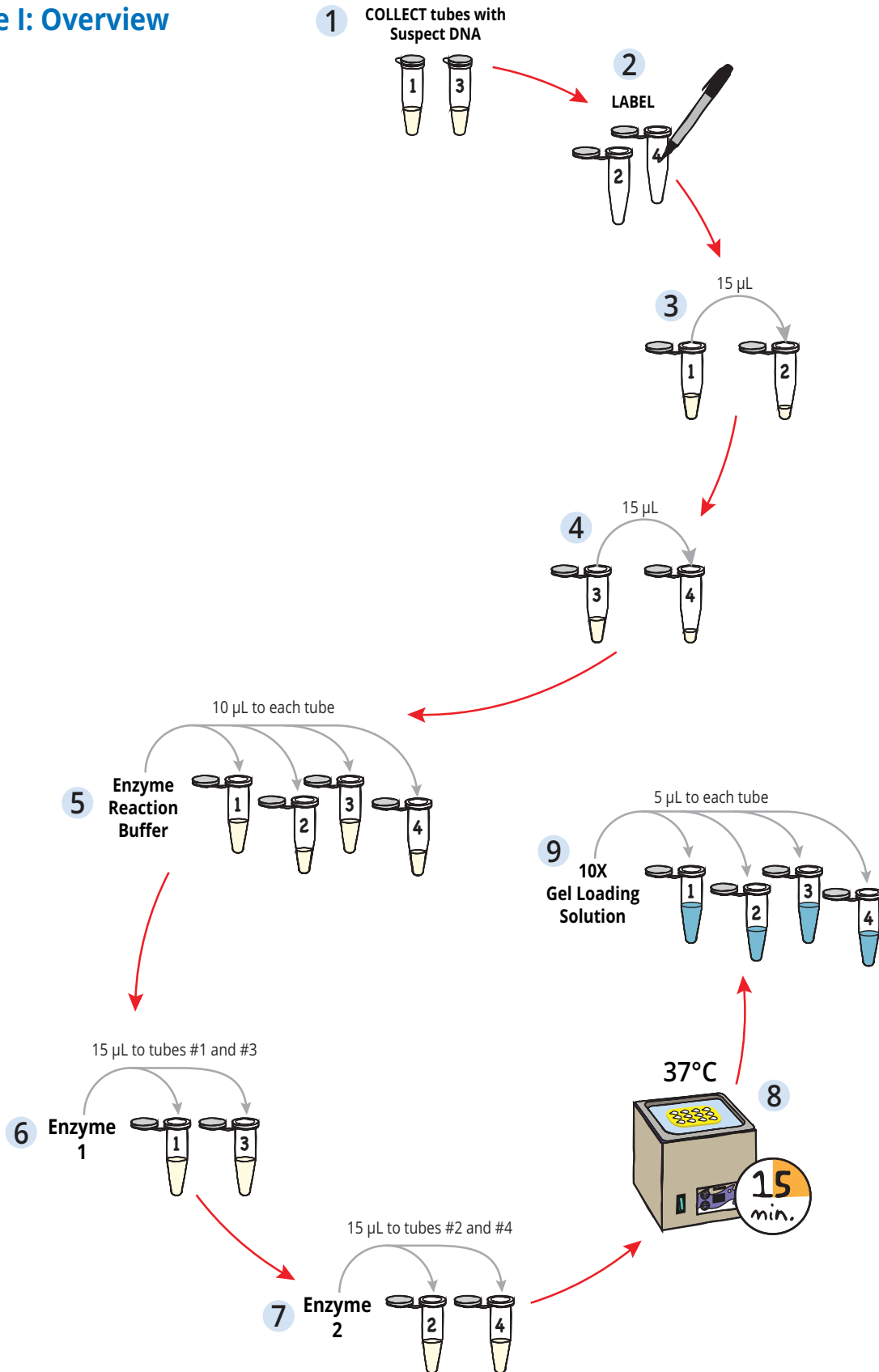

Module I: DNA Digestion with Restriction Enzymes

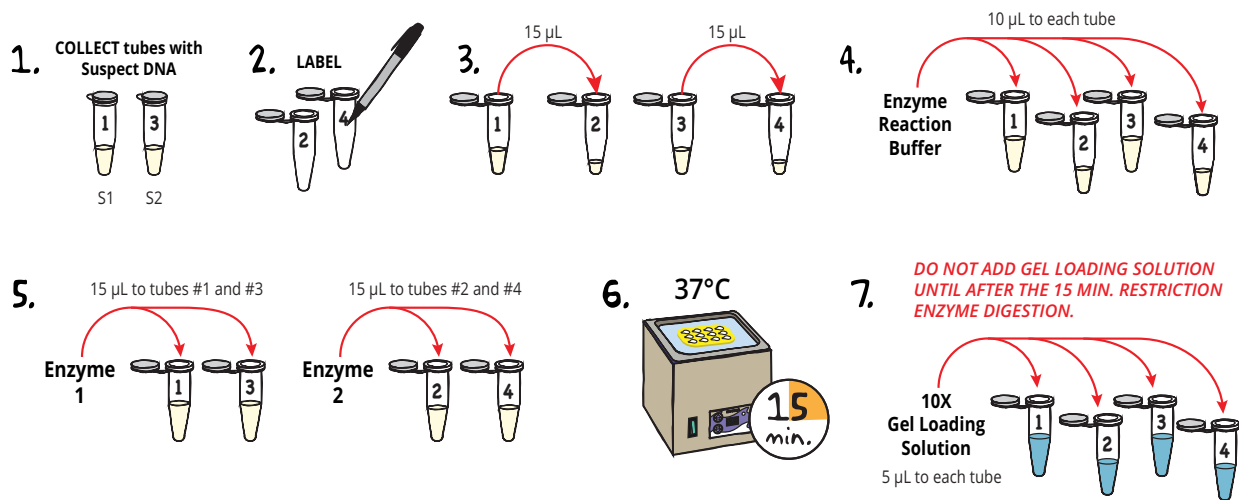

- COLLECT** two microtest tubes labeled #1 and #3 from your instructor. Tube #1 contains the DNA from Suspect 1 and Tube #3 contains the DNA from Suspect 2.
- LABEL** two empty microtest tubes as #2 and #4.
- TAP** tubes #1 and #3 on the lab bench to collect all the contents at the bottom of the tube. **TRANSFER** 15 µL from Tube #1 to Tube #2, then **TRANSFER** 15 µL from Tube #3 to Tube #4.
- Use an adjustable volume micropipette to **DISPENSE** 10 µL of Enzyme Reaction Buffer (Rxn Buffer) to each of four reaction tubes labeled 1 - 4.
- ADD** the enzymes to the reaction tubes as summarized in Table 1, below. Use a **FRESH** micropipette tip for each enzyme transfer. **NOTE: DO NOT ADD GEL LOADING SOLUTION AT THIS POINT!**
- PLACE** reaction tubes in a float and **INCUBATE** in a 37°C water bath for 15 minutes.



After the incubation is completed:

- ADD** 5 µL of 10x gel loading solution to reaction tubes 1 - 4 to stop the reactions.
- COLLECT** the following tubes from your instructor, each tube will contain 35 µL:
 - DNA Standard Marker
 - DNA from crime scene digested with Enzyme 1
 - DNA from crime scene digested with Enzyme 2
- PROCEED** to gel electrophoresis and follow Table 2 on page 16 for the Gel Loading Scheme.

IMPORTANT NOTE:
Do NOT add Gel loading solution until AFTER the 15 min. Restriction Enzyme Digestion.

Table 1: Summary of Restriction Enzyme Digestion Reactions

Reaction Tube	Suspect 1 DNA	Suspect 2 DNA	Reaction Buffer	Enzyme 1	Enzyme 2	10X Gel Load
#1	15 µL	-	10 µL	15 µL	-	5 µL
#2	15 µL	-	10 µL	-	15 µL	5 µL
#3	-	15 µL	10 µL	15 µL	-	5 µL
#4	-	15 µL	10 µL	-	15 µL	5 µL

Module II: Overview

If your lab has a blue light or UV transilluminator, it is recommended that you cast gels with SYBR® Safe Stain. However, FlashBlue™ Stain is also included for those who prefer to visualize on a white light source.

*If using SYBR® Safe Stain to visualize gels, add **DILUTED SYBR®** to molten agarose before pouring gels.*

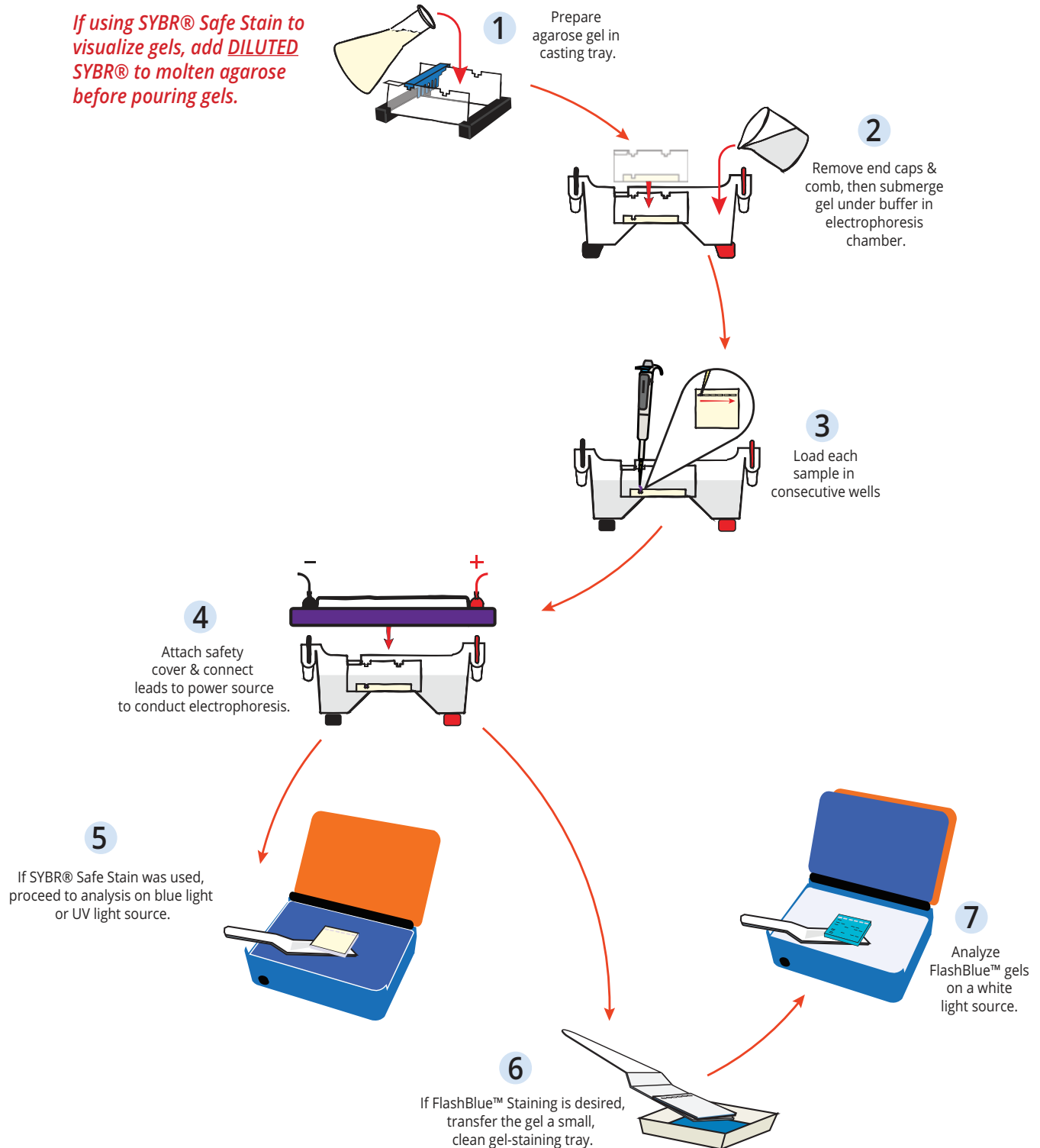

Module II: Gel Electrophoresis of Restriction Fragments

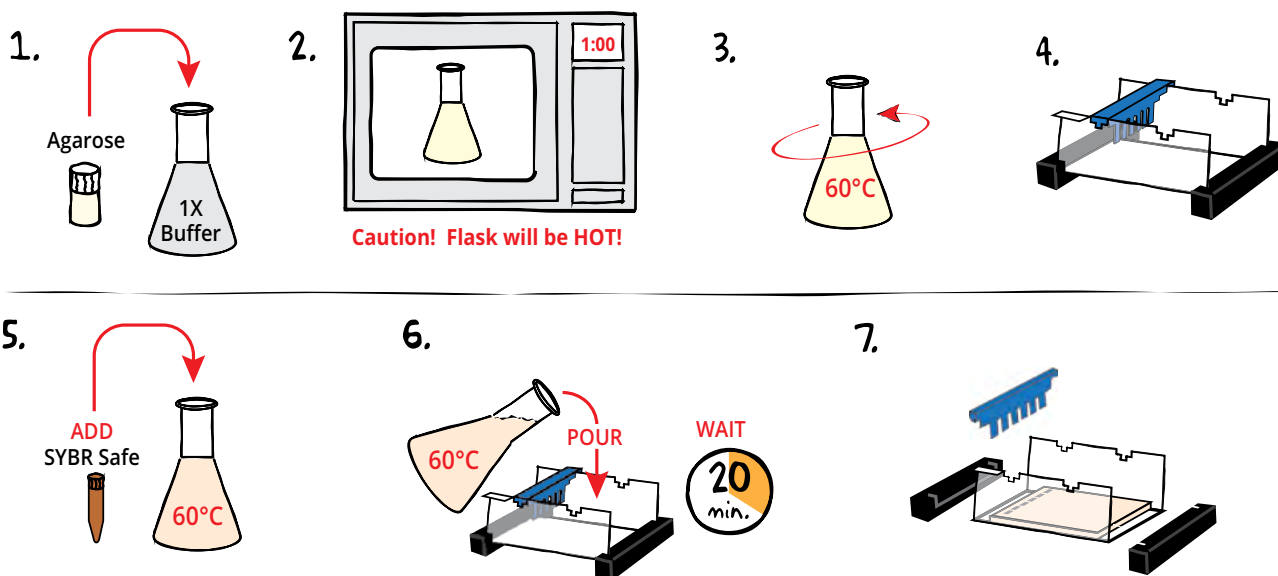

NOTE: If you are casting your own gels, review the following instructions. If you are using pre-cast gels, proceed to Step 8.

- MIX** agarose powder with 1X buffer in a 250 mL flask (see Table A).
- DISSOLVE** agarose powder by boiling the solution. **MICROWAVE** the solution on high for 1 minute. Carefully **REMOVE** the flask from the microwave and **MIX** by swirling the flask. Continue to **HEAT** the solution in 15-second bursts until the agarose is completely dissolved (the solution should be clear like water).
- COOL** agarose to 60°C with careful swirling to promote even dissipation of heat.
- While agarose is cooling, **SEAL** the ends of the gel-casting tray with the rubber end caps. **PLACE** the well template (comb) in the appropriate notch.

IF STAINING WITH SYBR® SAFE STAIN, proceed to step 5. If NOT using SYBR®, proceed to step 6.

- Before casting the gel, **ADD DILUTED SYBR® Safe** to the molten agarose and swirl to mix (see Table A).
- POUR** the cooled agarose solution into the prepared gel-casting tray. The gel should thoroughly solidify within 20 minutes. The gel will stiffen and become less transparent as it solidifies.
- REMOVE** end caps and comb. Take particular care when removing the comb to prevent damage to the wells.



Wear gloves and safety goggles

Reminder:

This experiment requires 1.2% agarose gels cast with 8 wells.

Size of Gel Casting Tray	Agarose	+	1X Buffer	+	<u>DILUTED</u> SYBR® (if using)
7 x 7 cm	0.36 g		30 mL		30 µL
10 x 7 cm*	0.6 g		50 mL		50 µL
14 x 7 cm	0.72 g		60 mL		60 µL

* Recommended gel volume for the EDGE™.

Module II: Gel Electrophoresis of Restriction Fragments, continued

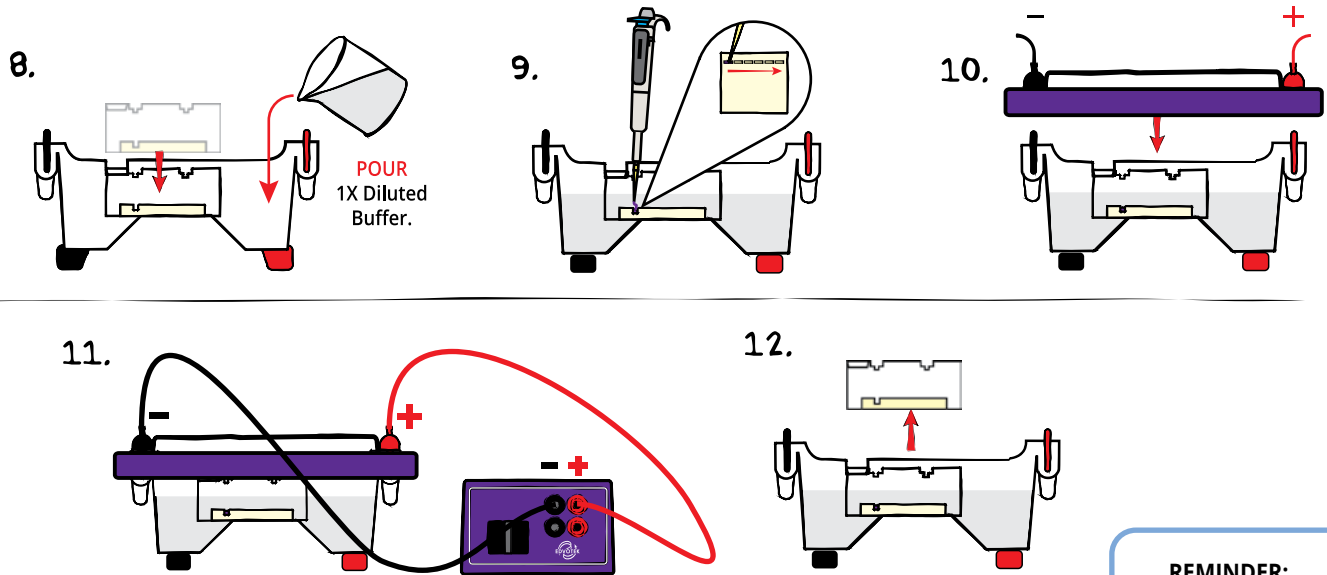

REMINDER:
Before loading the samples, make sure the gel is properly oriented in the apparatus chamber.

8. **PLACE** gel (on the tray) into electrophoresis chamber. **COVER** the gel with 1X electrophoresis buffer (See Table B for recommended volumes). The gel should be completely submerged.
9. **LOAD** the entire sample volume (35 μ L) into the well in the order indicated by Table 2.
10. **PLACE** safety cover. **CHECK** that the gel is properly oriented. Remember, the DNA samples will migrate toward the positive (red) electrode.
11. **CONNECT** leads to the power source and **PERFORM** electrophoresis (See Table C for time and voltage guidelines).
12. After electrophoresis is complete, **REMOVE** the gel and casting tray from the electrophoresis chamber. If SYBR® Safe Stain was used, proceed to **VISUALIZING THE SYBR® GEL** on page 17. If FlashBlue™ Staining is desired, proceed to page 18.

Table 2: Gel Loading Scheme

Lane	Sample	Vol. to Load
1	DNA Standard Marker	35 μ L
2	Crime scene DNA digested with Enzyme 1	35 μ L
3	Crime scene DNA digested with Enzyme 2	35 μ L
4	Tube 1 - Suspect 1/Enzyme 1	35 μ L
5	Tube 2 - Suspect 1/Enzyme 2	35 μ L
6	Tube 3 - Suspect 2/Enzyme 1	35 μ L
7	Tube 4 - Suspect 2/Enzyme 2	35 μ L

Table B

1x Electrophoresis Buffer (Chamber Buffer)

EDVOTEK Model #	Total Volume Required	Dilution	
		50x Conc. Buffer	+ Distilled Water
EDGE™	150 mL	3 mL	147 mL
M12	400 mL	8 mL	392 mL
M36	1000 mL	20 mL	980 mL

Table C

Time and Voltage Guidelines (1.2% Agarose Gel)

	Electrophoresis Model	
	EDGE™	M12/M36
Volts	Min/Max (minutes)	Min/Max (minutes)
150	20/30	25/35
100	35/45	40/50
75	NA	55/65

Module II: Gel Electrophoresis of Restriction Fragments, continued

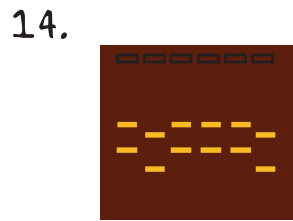

VISUALIZING THE SYBR® GEL

13. **SLIDE** gel off the casting tray onto the viewing surface of the transilluminator and turn the unit on. **ADJUST** the brightness to the desired level to maximize band visualization. DNA should appear as bright green bands on a dark background.
14. **PHOTOGRAPH** results.
15. **REMOVE** and **DISPOSE** of the gel and **CLEAN** the transilluminator surfaces with distilled water.

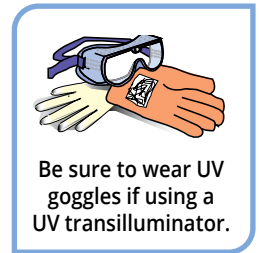

Module III: Staining Agarose Gels Using FlashBlue™ (OPTIONAL)

FlashBlue™ Stain is a simple and effective visible DNA stain that can be used as an alternative, or in addition to, UV reactive DNA stains like SYBR® Safe. *If staining with both SYBR® Safe and FlashBlue™, you must examine and record the SYBR® Safe bands before beginning the FlashBlue™ Staining.*

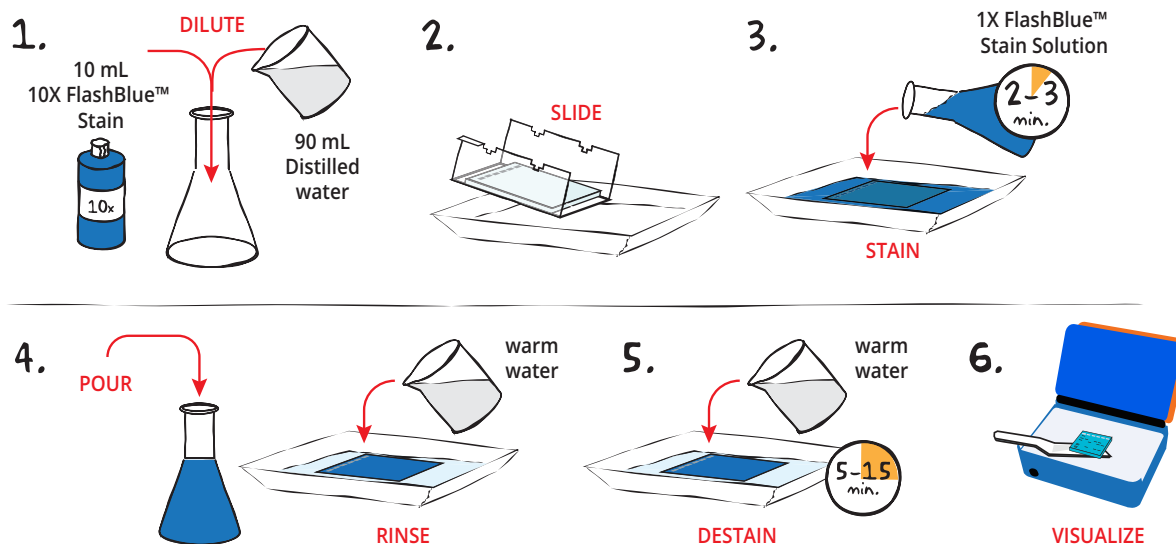

- DILUTE** 10 mL of 10X concentrated FlashBlue™ with 90 mL of distilled water in a flask. **MIX** well.
- REMOVE** the agarose gel and casting tray from the electrophoresis chamber. **SLIDE** the gel off the casting tray into a small, clean gel-staining tray.
- COVER** the gel with the 1X FlashBlue™ stain solution. **STAIN** the gel for 2-3 minutes. For best results, use an orbital shaker to gently agitate the gel while staining. **STAINING THE GEL FOR LONGER THAN 3 MINUTES WILL REQUIRE EXTRA DESTAINING TIME.**
- POUR** the 1X FlashBlue™ back into the flask (the stain can be reused). **COVER** the gel with warm water (40-45°C). Gently **RINSE** the gel for 20-30 seconds. **POUR** off the water.
- COVER** the gel with clean, warm water (40-45°C). **DESTAIN** for 5-15 minutes with gentle shaking (longer periods will yield better results). DNA bands will start to appear after 5 minutes of destaining. Changing the water frequently will accelerate destaining.
- Carefully **REMOVE** the gel from the destaining liquid. **VISUALIZE** results using a white light visualization system. DNA will appear as dark blue bands on a light blue background.



ALTERNATIVE FLASHBLUE™ STAINING PROTOCOL:

- DILUTE** 1 mL of 10X FlashBlue™ stain with 149 mL distilled water.
- COVER** the gel with diluted FlashBlue™ stain.
- SOAK** the gel in the staining liquid for at least three hours. For best results, stain gels overnight.
- Carefully **REMOVE** the gel from the staining liquid. **VISUALIZE** results using a white light visualization system. DNA will appear as dark blue bands on a light blue background.

Study Questions

1. Which suspect's DNA matches that found at the crime scene? Does this automatically mean that the suspect is guilty?
2. What possible experimental problems could occur to invalidate the results?
3. If only Restriction Enzyme 1 was used, would the interpretation be the same?

Instructor's Guide

ADVANCE PREPARATION:

Preparation for:	What to do:	When?	Time Required:
Module I: (~1 hour)	Thaw and dispense biologicals and reagents	Anytime before the class period	
	Prepare and aliquot Dryzymes™ *	30 minutes before	40 min.
	Equilibrate water bath to 37°C	1-2 hours before	10 min.
Module II: (45 min.)	Prepare diluted TAE buffer for electrophoresis	Anytime before the class period	15 min.
	Prepare diluted SYBR® Safe (if using)	Anytime before the class period	10 min.
	Prepare molten agarose and pour gels	One day to 30 min. before performing experiment	5 min.
Module III: (10 min.)	Dilute and distribute FlashBlue (if using)	Anytime before the class period	10 min.

Red = Prepare immediately before module.
 Yellow = Prepare shortly before module.
 Green = Flexible / prepare up to a week before the module.

* Dryzymes™ can be resuspended, then frozen for 1 week before the lab if need be.

Technical Support

1.800.EDVOTEK

Mon. - Fri. 8 AM to 5:30 PM EST



Please Have the Following Info:

- Product Number & Description
- Lot Number on Box
- Order/Purchase Order #

1.800.EDVOTEK • info@edvotek.com • www.edvotek.com

www.edvotek.com

- Online Catalog
- Order Products
- Experiment Protocols
- Tech Support
- Resources!



Notes for the Instructor

This experiment simulates a forensic case in which DNA samples from a hypothetical crime scene and suspects are digested by six-base cutting enzymes (*Eco* RI and *Hind* III). The objective is to analyze suspect DNA fingerprint patterns and compare them with "crime scene" samples. Each DNA sample will be cleaved with two restriction enzymes in separate reactions, and pairs of fragmentation patterns will serve as the fingerprints. The DNA fragmentation patterns will be analyzed in the stained agarose gel, without the need for Southern blot analysis.

This experiment module contains biologicals and reagents for eight groups. The experimental procedures consist of two major parts: (1) restriction enzyme digestion of DNA, which is followed by (2) agarose gel electrophoresis.

Each laboratory group receives two predigested, ready-for-electrophoresis "crime scene" samples and the DNA Standard Marker. Four additional DNA samples are generated by performing restriction enzyme digestion reactions on the DNAs of two suspects.

If you have eight (8) electrophoresis units, one for each of the eight lab groups, electrophoresis can be performed simultaneously by all eight groups. Alternatively, some lab groups can store their samples at 4°C and perform the electrophoresis at different times.

GEL ELECTROPHORESIS

The teacher instructions that come with the kit are very detailed. Follow the kit instructions for preparing the gels, running the gels, and staining the samples. Agarose gels can be made up to two weeks in advance and stored in the refrigerator wrapped in plastic wrap with 1-2 mL of 1X buffer to prevent drying. Do not freeze the gels. If time permits, you may want to have the students prepare their gels (especially if they did not do so previously).

NOTE: This kit contains two staining options - SYBR® Safe and FlashBlue™. Only one of these dyes should be used at a time. If the instructor chooses to use SYBR® Safe, it MUST be added to the molten agarose during gel casting. See the APPENDIX for instructions on how to properly dilute the SYBR® Safe. *SYBR® Safe must be diluted before being added to the molten agarose.*

Pre-Lab Preparations

GENERAL PREPARATIONS

1. Allow ample time to equilibrate a water bath at 37°C on the day of the experiment.
2. Each student group will perform 4 restriction enzyme reactions.

Each student group should receive the following materials:

- Reagents and biologicals summarized in Table 3.
- Automatic micropipette and tips.
- 4 microtest tubes with attached caps.
- Marking pen.

PREPARATION OF BIOLOGICALS AND REAGENTS

1. Thaw components A-F and I. Tap tubes on a table to get all of the sample to the bottom of the tube.
2. Two tubes, components B and C, contain DNA from the crime scene cut with restriction enzymes and are ready for electrophoresis. Sample B represents crime scene DNA cut with Restriction Enzyme 1. Sample C represents crime scene DNA cut with Restriction Enzyme 2.
 - Label eight tubes "CS1" or (B)
 - Label eight tubes "CS2" or (C)
 - Dispense 35 µL of each sample in the appropriate tubes for each of the eight lab groups.
3. Component F is the Enzyme Reaction buffer.
 - Label eight tubes "Rxn Buffer".
 - Dispense 45 µL of Enzyme Reaction buffer to each tube for each of the eight groups.
4. Label eight tubes "Gel Load" and dispense 25 µL of 10X Gel Loading Solution to each tube for each of the eight groups.

Preparation of Suspect DNAs

5. Using an automatic micropipette, dispense the two Suspect DNAs (D, E) for each of the eight lab groups.
 - For each of 8 groups, label two tubes: #1 and #3.
 - Dispense 30 µL of Suspect 1 DNA to tube #1 and 30 µL of Suspect 2 DNA to tube #3.

Table 3: Summary of Biologicals & Reagents for each group

Component	Label 8 Tubes	Dispense for each tube
A - DNA Standard Marker	DNA Marker	35 µL
B - Crime Scene DNA cut with Enzyme 1	CS1	35 µL
C - Crime Scene DNA cut with Enzyme 2	CS2	35 µL
D - DNA from Suspect 1	#1	30 µL
E - DNA from Suspect 2	#3	30 µL
F - Reaction Buffer	Rxn Buffer	45 µL
G - Diluted Enzyme 1	Enzyme 1	35 µL on ice
H - Diluted Enzyme 2	Enzyme 2	35 µL on ice
10X Gel Loading Solution	Gel Load	25 µL

IMPORTANT NOTE:

If class periods are short and do not allow enough time for students to prepare their own reaction tubes (Table 1, pg 13), they can be prepared ahead of time. **JUST WAIT UNTIL THE TIME OF THE LAB TO ADD THE ENZYME!**

Pre-Lab Preparations, continued

PREPARATION OF THE DRYZYME™ RESTRICTION ENZYMES

Prepare restriction digests within 30 minutes of reconstituting Dryzymes™.

NOTE: Dryzymes™ can be resuspended and frozen for 1 week before the lab, if need be.

1. Thaw Reconstitution Buffer (Component I) and place on ice.
2. Make sure that the solid material is at the bottom of the tubes. If not, centrifuge the tubes in a microcentrifuge at full speed for 20 seconds or tap the tube on the lab bench.
3. Add 300 µL Reconstitution Buffer (I) to the solid at the bottom of each tube containing Dryzymes™
4. Allow the samples to hydrate for 1 minute.
5. Mix the samples vigorously by flicking the tubes with your finger or by vortexing for 30 seconds until the solid appears to be completely dissolved.
6. Mix or vortex the samples and then centrifuge for 20 seconds or tap the tube on the lab bench.
7. After the rehydration, check that no undissolved particulate matter remains. If not completely dissolved, repeat mixing or vortexing.
8. Label eight tubes "Enzyme 1" and eight tubes "Enzyme 2"
9. Transfer 35 µL of diluted Restriction Enzyme 1 to each tube labeled "Enzyme 1". Cap tubes and immediately put on ice.
10. Transfer 35 µL of diluted Restriction Enzyme 2 to each tube labeled "Enzyme 2". Cap tubes and immediately put on ice.

Pre-Lab Preparations, continued

AGAROSE GEL ELECTROPHORESIS

This experiment requires a 1.2% agarose gel per student group. You can choose whether to prepare the gels in advance or have the students prepare their own. Allow approximately 30-40 minutes for this procedure.

DNA Standard Marker: Component A contains the DNA Standard Marker.

- Thaw the DNA Standard Marker (A).
- Label eight tubes "Marker".
- Dispense 35 μL of the DNA Standard Marker to each tube. Each group will receive one tube.

Prepare SYBR® Safe Stain:

1. Following the instructions in Appendix B, prepare 1x Electrophoresis Buffer by combining 10 μL of 50X Concentrated Buffer with 490 μL of distilled water.
2. Add 390 μL of the 1X buffer from step 1 to the tube of SYBR® Safe and mix by tapping the tube several times. The diluted SYBR® Safe Stain is now ready to be used during agarose gel preparation.

Individual Gel Preparation: Each student group can be responsible for casting their own individual gel prior to conducting the experiment. See Module II in the Student's Experimental Procedure. Students will need 50x concentrated buffer, distilled water, agarose powder, and diluted SYBR® Safe.

Batch Gel Preparation: To save time, a larger quantity of agarose solution can be prepared for sharing by the class. Electrophoresis buffer can also be prepared in bulk. See Appendix B.

Preparing Gels in Advance: Gels may be prepared ahead and stored for later use. Solidified gels can be stored in the refrigerator for up to 2 weeks. Place 1-2 mL of electrophoresis buffer in a sealable bag with the gels to prevent them from drying out. Excessive buffer will cause SYBR® Safe to diffuse out of the gels.

Do not freeze gels at -20°C as freezing will destroy the gels.

Gels that have been removed from their trays for storage should be "anchored" back to the tray with a few drops of molten agarose before being placed into the tray. This will prevent the gels from sliding around in the trays and the chambers.

Pre-Lab Preparations, continued

STAINING AGAROSE GELS WITH FLASHBLUE™ (OPTIONAL)

FlashBlue™ can be used as an alternative or in addition to SYBR® Safe in this experiment. If only staining with FlashBlue™, you can omit SYBR® Safe from the gel preparation. However, FlashBlue™ is less sensitive than SYBR® Safe and will take a longer time to obtain results. Alternatively, gels can be visualized first with SYBR® Safe and then with FlashBlue™.

Agarose gels can be stained with diluted FlashBlue™ for 5 minutes and destained for only 20 minutes. For the best results, leave the gel in liquid overnight. This will allow the stained gel to develop in the destaining solution, resulting in dark blue DNA bands that contrast with a uniformly light blue background. A white light box is recommended for visualizing gels stained with FlashBlue™.

- Stained gels may be stored in destaining liquid for several weeks if they are refrigerated, although the bands may fade with time. If this happens, re-stain the gel.
- Destained gels should be discarded in the garbage and destaining solutions should be disposed of down the drain.

Photodocumentation of DNA (Optional)

Once the gels are stained, you may wish to photograph your results. There are many different photodocumentation systems available, including digital systems that interface directly with computers. Specific instructions will vary depending upon the type of photodocumentation system you are using.

Experiment Results and Analysis

EXPECTED RESULTS

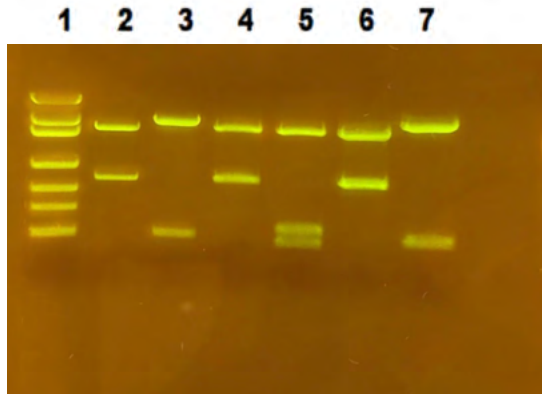

The restriction digest pattern from crime scene samples matches Suspect 2. This suggests Suspect 2 was at the crime scene.

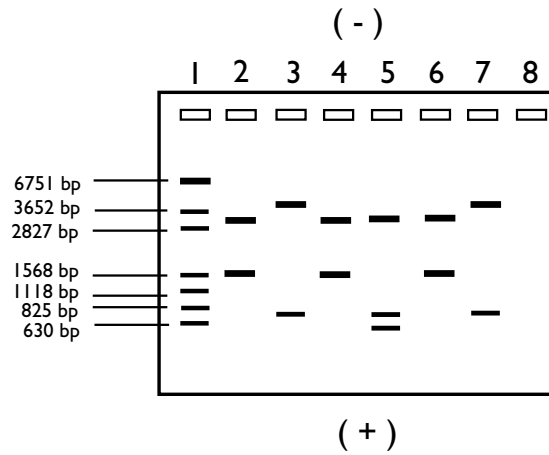

In the idealized schematic, the relative positions of DNA fragments are shown but are not depicted to scale.

Lane	Tube	Sample	Molecular Weight
1	Markers	DNA Standard Marker	6751, 3652, 2827, 1568, 1118, 825, 630
2	CS1	Crime scene DNA cut with Enzyme 1	3000, 1280
3	CS2	Crime scene DNA cut with Enzyme 2	3650, 630
4	1	DNA from Suspect 1 cut with Enzyme 1	3000, 1280
5	2	DNA from Suspect 1 cut with Enzyme 2	3000, 760, 650
6	3	DNA from Suspect 2 cut with Enzyme 1	3000, 1280
7	4	DNA from Suspect 2 cut with Enzyme 2	3650, 630

**Please refer to the kit
insert for the Answers to
Study Questions**

Appendix A

Troubleshooting Guide

PROBLEM:	CAUSE:	ANSWER:
The DNA did not digest	The restriction enzymes were not active.	Be sure that the restriction enzymes were diluted in the correct buffer.
		For optimal activity, prepare the enzymes within 30 minutes of use.
There are bands on my gels that can't be explained by the restriction digests.	Some bands may represent partially digested DNA.	The sample was not digested at the right temperature.
		The sample was not digested for the appropriate amount of time.
The ladder and samples are not visible on the gel.	The gel was not prepared properly.	Ensure that the electrophoresis buffer was correctly diluted.
		Gels of higher concentration (>0.8%) require special attention when melting the agarose. Make sure that the solution is completely clear of "clumps" and glassy granules before pouring gels.
	The gel was not stained properly.	Repeat staining.
After staining the gel, the DNA bands are faint.	Malfunctioning electrophoresis unit or power source.	Contact the manufacturer of the electrophoresis unit or power source.
	The gel was not stained for a sufficient period of time.	Repeat staining protocol.
	DNA stained with FlashBlue may fade over time.	Re-stain the gel with FlashBlue.
After staining the gel, the ladder and control samples are visible on gel, but some student samples are not present.	The background of the gel is too dark.	Destain gel for 5-10 minutes in distilled water.
	Wrong volumes of DNA and enzyme added to restriction digest.	Practice using pipettes.
There is no separation between DNA bands, even though the tracking dye ran the appropriate distance.	The wrong percent gel was used for electrophoretic separation.	Be sure to prepare the correct percent agarose gel. For reference, the DNA samples should be analyzed using a 0.8% agarose gel.
DNA bands were not well resolved.	Tracking dye should migrate at least 3.5 cm from the wells to ensure adequate separation.	Be sure to run the gel at least 3.5 cm before staining and visualizing the DNA .

Appendix B

Bulk Preparation of Electrophoresis Buffer and Agarose Gels

To save time, the electrophoresis buffer and agarose gel solution can be prepared in larger quantities for sharing by the class. Unused diluted buffer can be used at a later time and solidified agarose gel solution can be remelted.

Bulk Electrophoresis Buffer

Quantity (bulk) preparation for 3 liters of 1x electrophoresis buffer is outlined in Table D.

Amount of 50X TAE	Amount of Distilled Water	Final Volume
20 mL	980 mL	1000 mL
40 mL	1960 mL	2000 mL
60 mL	2940 mL	3000 mL

Batch Agarose Gels (1.2%)

For quantity (batch) preparation of 1.2% agarose gels, see Table E.

- Use a 500 mL flask to prepare the diluted gel buffer.
- Pour 4.8 grams of UltraSpec-Agarose™ into 400 mL of prepared 1X TAE buffer. Swirl to disperse clumps.
- With a marking pen, indicate the level of solution volume on the outside of the flask.
- Heat the agarose solution as outlined previously for individual gel preparation. The heating time will require adjustment due to the larger total volume of gel buffer solution.
- Cool the agarose solution to 60°C with swirling to promote even dissipation of heat. If evaporation has occurred, add distilled water to bring the solution up to the original volume as marked on the flask in step 3.
- If staining with SYBR® Safe, add the entire tube of diluted stain (see page 21) to the cooled agarose and mix well.
- Dispense the required volume of cooled agarose solution for casting each gel. Measure 30 mL for a 7 x 7 cm tray, 50 mL for a 10 x 7 cm tray, and 60 mL for a 14 x 7 cm tray. *For this experiment, 7 x 7 cm gels are recommended.*
- Allow the gel to completely solidify. It will become firm and cool to the touch after approximately 20 minutes. Then proceed with preparing the gel for electrophoresis.

NOTE:

The UltraSpec-Agarose™ kit component is usually labeled with the amount it contains. Please read the label carefully. If the amount of agarose is not specified or if the bottle's plastic seal has been broken, weigh the agarose to ensure you are using the correct amount.

# of Gels	Amount of Agarose Powder	Amount of 1X TAE Buffer	Amount of Diluted SYBR® Safe (if using)
1	0.6 g	50 mL	50 µL
2	1.2 g	100 mL	100 µL
3	1.8 g	150 mL	150 µL
4	2.4 g	200 mL	200 µL
8 (batch prep)	4.8 g	400 mL	400 µL